



Type: Bullet - Thermal Imaging - Camera
 Item Code: GU-TI-AP4607T
 EAN CODE: 4260573065776

SMART

The SMART product line offers comprehensive coverage of modern video systems with advanced AI analysis and solutions for various application areas.

Highlights

H.265+

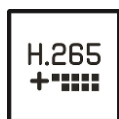

H.265pro+ utilizes the standard H.265/High Efficiency Video Coding (HEVC) format, but boasts advanced technologies that enable it to substantially reduce the necessary transmission bandwidth and storage capacity for maximum efficiency.

Object Classification



This technology employs a highly advanced deep learning algorithm that can discern whether the alarm was triggered by a human, a vehicle or some other object.

Smartphone App

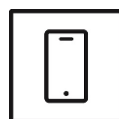

The mobile application was developed to facilitate operators in effectively controlling and managing video systems remotely, at any time. It allows for live image viewing, playback of recorded video data, and receipt of remote notifications.

Deep Learning

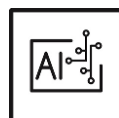

Deep Learning is inspired by the complex structure of the human brain. This innovative method allows processing of information and performing corresponding actions based on analysis.

Active Deterrence

The Active Deterrence system helps deter potential intruders at an early stage. Thanks to built-in light sources and/or speakers, possible criminal activities can be prevented before they occur. Depending on the scenery, cameras with either a white or a red-blue light source are available. With its integrated deep-learning algorithm, the system can reliably identify individuals. If an intrusion alarm is triggered, it not only sends an alert but also delivers the corresponding video footage directly to a mobile device in real-time.

Features

- Reduction of unwanted alarms (false alarms) by classifying target objects using deep learning algorithms. This significantly reduces false alarms generated by objects other than people or vehicles. This makes finding events easier and saves hard drive capacity
- Dual Streaming with 1 infrared channel and 1 optical channel
- 0 Lux: Integrated LED IR Illuminator viewable distance up to 50m
- Many intelligent functions: deep learning distinguishing between human and vehicles, face detection and capture, line crossing and intrusion alarm
- Audio Communication & Alarm Input / Output
- Picture in Picture - Partial image of infrared channel on the full image of optical channel

- Built in Microphone/ Speaker echo cancellation

NDA compliant

GRUNDIG Security's SMART line is fully compliant with the National Defense Authorization Act (NDA), which prohibits U.S. federal agencies and their partners from using video surveillance and telecommunications equipment or services from certain Chinese companies. This law is part of the John S. McCain NDA and is effective August 2020.

With our SMART product line, you can be confident that your security system complies with this important regulation. Our products meet the highest standards of quality and reliability, providing you with the security you need to protect your assets and personnel.

Specifications GU-TI-AP4607T

Thermal module

Thermal Sensor:	Vanadium Oxide Uncooled Focal Plane Array
Resolution (Thermal):	256 x 192
IFOV:	1.69 mrad
NETD:	< 40 mk (@25° C, F=1.0)
Response Waveband:	8 µm to 14 µm
Detector Pitch:	12 µm
Focal Length (IR):	7 mm
Viewing Angle (IR):	25° x 18.7° (HxV)
MOD (Min. Object Distance):	1 m

Camera

Image Sensor:	1/2.7" progressive Scan CMOS
Video Resolution:	2592 x 1944
Sensitivity Colour:	0.003 Lux @ F1.6 (AGC ON)
Shutter Speed:	1/5 ~ 1/20000 s

Lens

Lens Focal Length:	8 mm
Iris F-Number:	F1.0
Field of View:	42° (horizontal), 23° (vertical), 49° (diagonal)

Illuminator

Max. IR Distance:	Up to 50 m
White Light Distance:	Up to 30 m
White LED:	Alarm/ Off

Video

Wide Dynamic Range:	120 dB
Day/Night Switch:	Color, BW, Auto

Audio

Audio Compression:	G.711
Audio Detection:	Detects unusual noises: dogs barking, babies crying, gunshots, sudden sound increase and decrease

General

Fire Detection:	Supported
Measurement option:	Support 3 temperature measurement rule types (12 points, 12 regions and 12 lines)
Object Temperature Range:	- 20°C to 550°C
Accuracy:	± 3°C / 3%

General

DRI Range:	<p>Detection Range, Vehicles 1.4 m x 4.0 m: 920 m Detection Range, Humans 1.8 m x 0.5 m: 277 m Recognition Range, Vehicles 1.4 m x 4.0 m: 230 m Recognition Range, Humans 1.8 m x 0.5 m: 79 m Identification Range, Vehicles 1.4 m x 4.0 m: 115 m Identification Range, Humans 1.8 m x 0.5 m: 40 m Heat Detection Distance: 60 m</p> <p>The DRI (detect, recognize, identify) distance gives the general idea of the camera ability to distinguish persons or objects within its field of view. It is calculated based on the camera sensor specification and the criteria given by EN 62676-4: 2015.</p>
Smart Function Range:	<p>VCA Range, Vehicles 1.4 m x 4.0 m: 170 m VCA Range, Humans 1.8 m x 0.5 m: 60 m Temperature Measurement: 60 m</p>

Frame Rate

Main Stream:	<p>Thermal: 25 fps (1280 x 720, 640 x 480) Optical: 50 Hz: 25 fps (2592 x 1944, 2592 x 1520, 2048 x 1536, 2304 x 1296, 1920 x 1080, 1280 x 960) 60 Hz: 30 fps (2592 x 1944, 2592 x 1520, 2048 x 1536, 2304 x 1296, 1920 x 1080, 1280 x 960)</p>
Sub- Stream:	<p>Thermal: 25 fps (640 x 480, 320 x 240) Optical: 50 Hz: 25 fps (1280 x 720, 640 x 480, 320 x 240) 60 Hz: 30 fps (1280 x 720, 640 x 480, 320 x 240)</p>
3rd Stream:	<p>Thermal 25 fps: (640 x 480, 320 x 240) Optical 50Hz 25fps (1280 x 720, 640 x 480. 320 x 240) 60 Hz: 30 fps (1280 x 720, 640 x 480. 320 x 240)</p>

Network

Users:	2 Levels: Administrator, Operator
Number of Clients:	Up to 14 simultaneously
Video Compression:	H.264, H.264+, H.265, H.265+, MJPEG
SD Memory:	Micro SD/SDHC/SDXC card slot with ANR (up to 512G), NAS (Support NFS, SMB/CIFS)
Client software:	C-WERK Viewer, Smart-Line Client PC-Software, IOS App, Android App (GSVM)
Web Browser:	<p>Plug-in required live view: IE10/IE11 Non Plug-in live view: Chrome 57+, Mozilla Firefox 52+, EDGE 89+ Local Service: Chrome 57+, Firefox 52+, EDGE 89+</p>
Network Protocol:	TCP/IP, HTTP, HTTPS, FTP, DHCP, DNS, RTP, RTSP, RTCP, NTP, SMTP, SNMP, IPv4/IPv6
Cyber Security:	3 levels of user management: admin, operator, user, AES Encryption for Password Protection, Complicated Password, HTTPS (SSL) Login Authentication, Basic and digest authentication for HTTP/HTTPS, 802.1X authentication (EAP-TLS), 802.1X authentication (EAP-MD5), Watermark, IP Adress Filter, WSSE and digest authentication for ONVIF, RTP/RTSP over HTTPS, Control timeout settings, Security audit log, SNMP V2, SNMP V3, TLS 1.1, TLS 1.2, TLS 1.2 with updated cipher suites including AES 256 encryption. Brute Force Delay Protection, Signed Firmware, Secure Boot by software check

I/O Interface

Audio Input/Output:	1 Input: line in or mic in & built-in microphone, 1 Output: line out & built in speaker, mono sound
Alarm Input/Output:	1, 1
Network Interface:	1x 10, 100 Base T (Ethernet), TX (RJ-45)

Intelligent Functions

People & Vehicle Detection:	Adjustable whether people, motorized or non-motorized vehicles should be detected.
-----------------------------	--

Intelligent Functions

Intrusion Detection:	Enter and loiter in a pre-defined virtual region
Line Crossing:	Cross a pre-defined virtual line
Region Entrance:	Enter a pre-defined virtual region from the outside place
Region Exiting:	Exit from a pre-defined virtual region
Unattended Baggage:	Objects left over in the pre-defined region such as the baggage, purse, dangerous materials
Object Removal:	Detects objects left over or lost in the pre-defined region such. In this case an alarm notification or signal will be sent automatically and in real time.
Object Counting:	People, motorized vehicles, non-motorized vehicles or other movements are counted when crossing a virtual line and the result is displayed on the screen in real time
Face Detection:	Real-time face recognition and instant comparison with a list of people (the comparison only works via a connected NVR)
Heat Map:	Visualizes the number of people in the surveillance area over a period of time with a simple and user-friendly color scheme
Queue Length Detection:	Counts people in a predefined area and measures service time. The area, the maximum number of people in it and the maximum service time can be set
Crowd Density Detection:	Counts people in a predefined area. The area, the maximum number of people in it can be set
Event Source:	Video tampering, motion, various AI functions, sudden audio increase-decrease
Event Action:	Recording: Pre-event, post-event memory card and/or network storage. Picture upload: FTP, HTTP and NAS. Trigger E-mail notification: HTTP, ISAPI. Audio alarm, white light alarm, alarm output and notification to C-WERK VMS. Events are depending on schedule settings.
Sound Alarm:	2 types of audible alarm (VCA and Temperature) 3 costum alarms, voice shared by all alarm events 6 importable user-defined voice alerts (6 options shared in the two types)
Visual Alarm:	Red & Blue light alarm with adjustable flashing frequencies

Approvals

Protection Rating:	IP67 (IEC 60529-2013), NEMA 4X (NEMA 250-2018)
Standard:	ONVIF (Profile S, Profile G, Profile T, Profile M), SDK/API

Environmental

Operating Temperature:	-35 °C ~ 60 °C (-31 °F ~ 140 °F)
Humidity:	Less than 90%, non condensing

Electrical

Supply Voltage:	12 VDC, PoE (IEEE 802.3af)
Power Consumption:	Max. 11 W

Mechanical

Dimensions:	∅ 130 x 350 mm (∅5.12 x 13.78 inch)
Weight:	1235 g (2.72 lb)

Packaging

Package Dimensions:	180 x 180 x 420 mm (7.1 x 7.1 x 16.53 inch)
Package Weight:	2300 g (5.1 lbs)

Accessories



GD-CW-VIEWER



GD-CW-FINDER

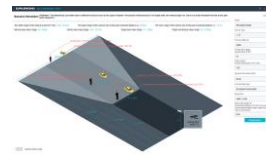

GU-SW-INST-TOOL

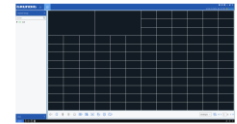

GU-SW-VMS

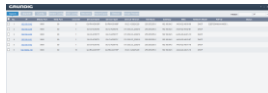

GU-SW-IP-FINDER



GU-SW-PLAYER



GD-HW-SD-128GB



GD-HW-SD-256GB

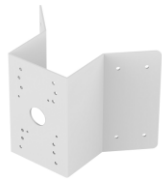

GU-BR-AMC01



GU-BR-AML01

Dimensions

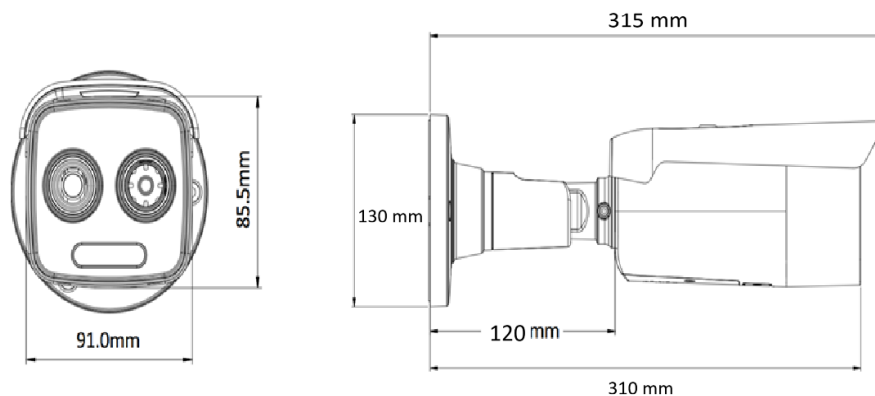

Smart Line

In addition to the usual reliability, the SMART product line from GRUNDIG Security offers numerous image analysis functions, supported by artificial intelligence (AI). For example, use the LPR function to recognize license plates or facial recognition to identify people. Or reduce the number of false alarms by classifying objects as 'Vehicle', 'Person' or 'Other'. GRUNDIG Security's SMART cameras are able to detect people in crowds, count the number of heads and measure the length of queues, e.g. B. to be determined in the checkout area. In this way, they help you to use your resources optimally. They also inform you if unauthorized people cross predefined lines or enter certain areas.

Guarantee

All cameras in the "SMART", "PRO" and "PREMIUM" product lines have an extended warranty period of 5 years on electronic parts, mechanical wear and tear on moving parts is not included. Please note our general delivery terms and conditions.